

ACO slivnik 157 FHD iz nehrđajućeg čelika – jednodijelni

Opis proizvoda

- Higijenski dizajn prema EN 14159, EN ISO 14159 i i EHEDG dokumentu br. 8, 13 i 44
- Testirano i certificirano prema HRN EN 1253
- Dostupno u kvaliteti nehrđajućeg čelika 1.4301 (AISI 304) ili 1.4404 (AISI 316L)
- Svi rubovi zaobljeni u radijusu za brzo otjecanje vode bez mogućnosti zadržavanja
- Izvadivi zapor za miris iz nehrđajućeg čelika, higijenskog dizajna za lagano održavanje
- Protok slivnika 2,6 l/s sa izljevom DN 70, do 3,5 l/s sa izljevom DN 100
- Dimenzija dosjeda: 200 × 200 mm za rešetku 168x168 mm te 250x250 mm za rešetku 218x218 mm
- Izljevna cijev DN 70/DN 100 (promjer 75 mm ili 110 mm)
- Široka paleta pokrovnih rešetki klase L15–M125 (HRN EN 1253) uklj. C250 (HRN EN 124)
- Opcija košarica za sakupljanje nečistoća kapaciteta 0,6 litara

ACO slivnik 157 FHD – jednodijelni – izljev DN 70

Ilustracija/Crtež	FHD	Dimenzija dosjeda [mm]	Promjer izljevne cijevi [mm]	Težina [kg]	Kvaliteta materijala	
					AISI 304	AISI 316L
	●	200x200	DN 70	3,00	408001	408101
	●	200x200	DN 70	3,80	408047	408147
	●	250x250	DN 70	3,30	408017	408117
	●	200x200	DN 70	2,90	408009	408109
	●	200x200	DN 70	3,50	408014	408114
	●	250x250	DN 70	3,40	408025	408125

ACO slivnik 157 FHD iz nehrđajućeg čelika – jednodijelni

ACO slivnik 157 FHD – jednodijelni – izljev DN 100

Ilustracija/Crtež	FHD	Dimenzija dosjeda [mm]	Promjer izljevne cijevi [mm]	Težina [kg]	Kvaliteta materijala	
					AISI 304	AISI 316L
	●	200x200	DN 100	3,00	408003	408103
	●	200x200	DN 100	3,80	408099	408199
	●	250x250	DN 100	3,50	408019	408119
	●	200x200	DN 100	2,90	408011	408111
	●	200x200	DN 100	3,60	408015	408115
	●	250x250	DN 100	3,40	408027	408127

ACO slivnik 157 FHD iz nehrđajućeg čelika – teleskopski

Opis proizvoda

- Higijenski dizajn prema EN 14159, EN ISO 14159 i i EHEDG dokumentu br. 8, 13 i 44
- Testirano i certificirano prema HRN EN 1253
- Dostupno u kvaliteti nehrđajućeg čelika 1.4301 (AISI 304) ili 1.4404 (AISI 316L)
- Svi rubovi zaobljeni u radijusu za brzo otjecanje vode bez mogućnosti zadržavanja
- Izvadiivi zapor za miris iz nehrđajućeg čelika, higijenski dizajna za lagano održavanje
- Protok slivnika 2,6 l/s sa izljevom DN 70, do 3,5 l/s sa izljevom DN 100
- Teleskopski podesiva visina i zakretanje slivne rešetke
- Slivnik moguće kombinirati sa dosjedom 200x200 mm / 250x250 mm ili linijskim Box/Slot/Tray kanalima
- Slivnici opremljeni prirubicama za prihvat vodonepropusne membrane
- Izljevna cijev DN 70/DN 100 (promjer 75 mm ili 110 mm)
- Široka paleta pokrovnih rešetki klase L15–M125 (HRN EN 1253) uklj. C250 (HRN EN 124)
- Opcija košarica za sakupljanje nečistoća kapaciteta 0,3 ili 0,6 litara

ACO slivnik 157 FHD – teleskopski – izljev DN 70

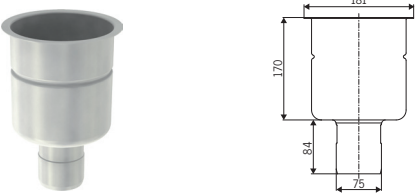
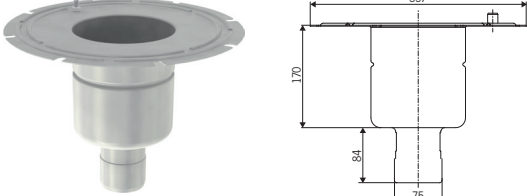
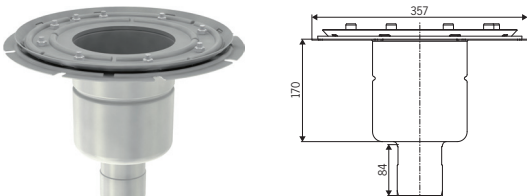
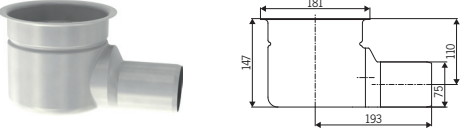
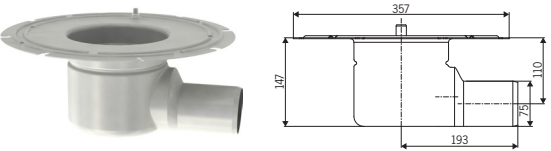
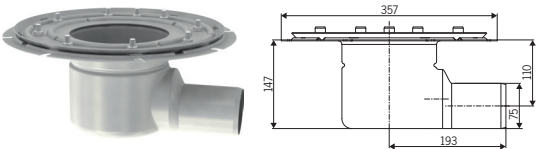
Ilustracija/Crtež	FHD	Tip prirubnice	Promjer izljevne cijevi [mm]	Težina [kg]	Kvaliteta materijala	
					AISI 304	AISI 316L
	●	Bez	DN 70	2,30	408049	408149
	●	Lijepljenje	DN 70	3,30	408051	408151
	●	Uklještenje	DN 70	4,20	408053	408153
	●	Bez	PDN 70	2,20	408073	408173
	●	Lijepljenje	DN 70	3,10	408075	408175
	●	Uklještenje	DN 70	4,10	408077	408177

ACO slivnik 157 FHD iz nehrđajućeg čelika – teleskopski

ACO Slivnik 157 FHD – teleskopski – izljev DN 100

Ilustracija/Crtež	FHD	Tip prirubnice	Promjer izljevne cijevi [mm]	Težina [kg]	Kvaliteta materijala	
					AISI 304	AISI 316L
	•	Bez	DN 100	2,30	408055	408155
	•	Lijepljenje	DN 100	3,30	408057	408157
	•	Uklještenje	DN 100	4,30	408059	408159
	•	Bez	DN 100	2,20	408079	408179
	•	Lijepljenje	DN 100	3,20	408081	408181
	•	Uklještenje	DN 100	4,10	408083	408183

ACO slivnik 157 FHD iz nehrđajućeg čelika – teleskopski

ACO slivnik 157 FHD – dosjed za rešetku

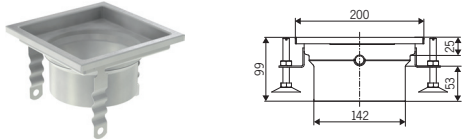
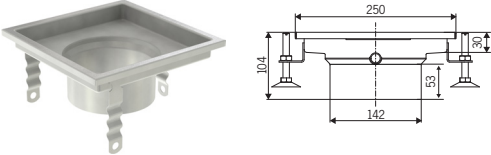
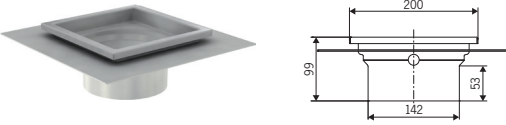
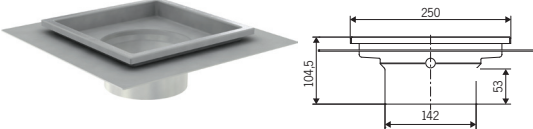
Ilustracija/Crtež	FHD	Opis ruba	Dimenzija dosjeda [mm]	Težina [kg]	Kvaliteta materijala	
					AISI 304	AISI 316L
	●	Standardni rub	200x200	1,20	408028	408218
	●	Standardni rub	250x250	1,60	408248	408258
	●	Prošireni rub za plitku HI	200x200	1,90	408241	408251
	●	Prošireni rub za plitku HI	250x250	2,40	408245	408255

ACO slivnik 157 FHD iz nehrđajućeg čelika – pokrovne rešetke

ACO slivnik 157 FHD – rešetke za dosjed 200x200 mm

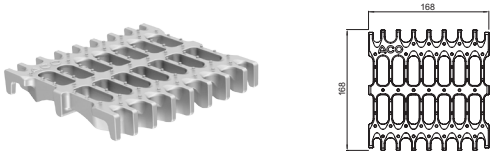
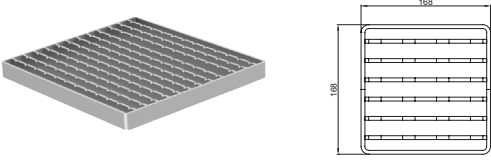
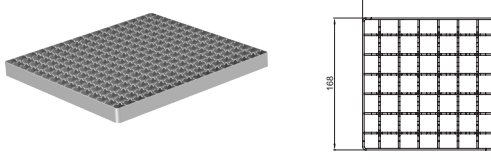
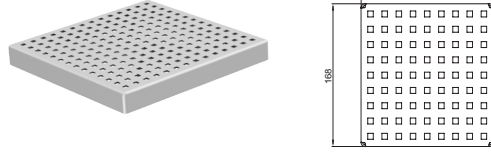
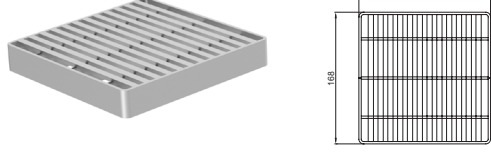
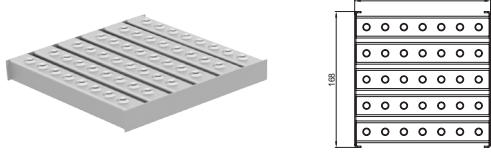
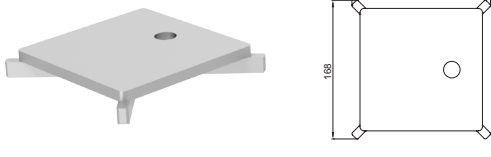
Ilustracija/Crtež	FHD	Dizajn i nosivost	Završna obrada	Protukliznost	Kvaliteta materijala	
					AISI 304	AISI 316L
	●	Lijevana M125	elektro polirana	da	416942	-
	●	Prečkasta R50	piko pasivizirana	da	416912	416913
	●	Prečkasta M125		da	408093	409193
	●	Prečkasta C250		ne	408043	408143
		Mrežasta L15	elektro polirana	da	408090	408190
				ne	408091	408191
		Quadratto L15	piko pasivizirana	ne	408092	408192
		Heelsafe L15	piko pasivizirana	ne	408022	408122
		Volcano L15	elektro polirana	da	408094	408194
		Slot M125	piko pasivizirana	ne	408021	408121

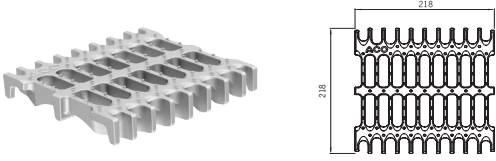
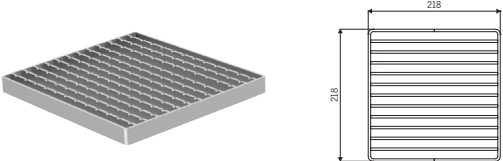
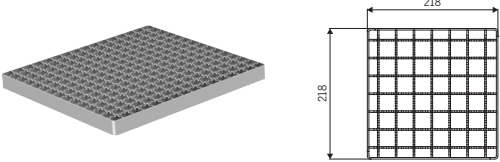
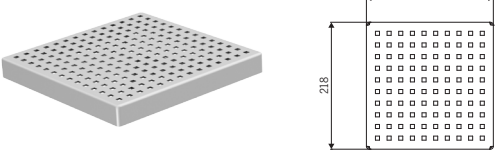
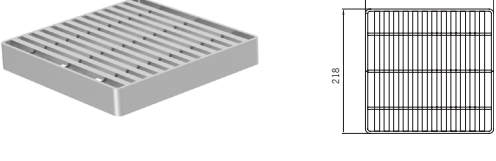
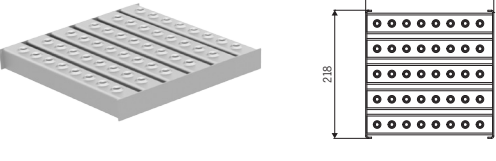
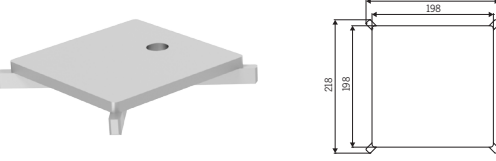

ACO slivnik 157 FHD iz nehrđajućeg čelika – pokrovne rešetke

ACO slivnik 157 FHD – rešetke za dosjed 250x250 mm

Ilustracija/Crtež	FHD	Dizajn i nosivost	Završna obrada	Protukliznost	Kvaliteta materijala	
					AISI 304	AISI 316L
	●	Lijevana M125	elektro polirana	da	416943	-
	●	Prečkasta R50	piko pasivizirana	da	416914	416915
	●	Prečkasta M125		da	408028	408128
	●	Prečkasta C250		ne	408044	408144
		Mrežasta L15	elektro polirana	da	408095	408195
				ne	408096	408196
		Quadratto L15	piko pasivizirana	ne	408097	408197
		Heelsafe L15	piko pasivizirana	ne	408031	408131
		Volcano L15	elektro polirana	da	408033	408133
		Slot M125	piko pasivizirana	ne	408030	408130

ACO slivnik 157 FHD iz nehrđajućeg čelika – teleskopski

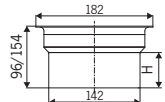
ACO slivnik 157 FHD – teleskopski – dodatna priborica

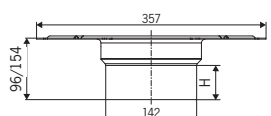
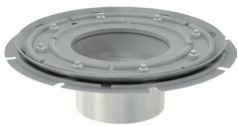
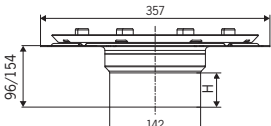
Ilustracija/Crtež	FHD	Tip priborice	visina [mm]	Težina [kg]	Kvaliteta materijala	
					AISI 304	AISI 316L
 	●	Bez	53	0,6	408249	408259
			111	2,30	408229	408239
 	●	Lijepljenje	53	1,9	408206	408216
			111	2,80	415242	-
 	●	Uklještenje	53	2,9	408207	408217
			111	3,70	415244	415245

ACO Slivnik 157 FHD – košarica za nečistoće

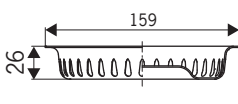

Ilustracija/Crtež	FHD	Odgovara	Volumen [lit]	Težina [kg]	Kvaliteta materijala	
					AISI 304	AISI 316L
 	●	Za horizontalne slivnike	0,3	0,27	416906	416907
		Za vertikalne slivnike	0,6	0,33	416904	416905

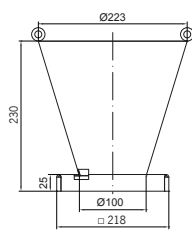
ACO slivnik 157 FHD – lijevak za prihvat tekućine

Ilustracija/Crtež	FHD	Odgovara	Kvaliteta materijala	
			AISI 304	AISI 316L
 	●	za dosjed rešetke dimenzije 200x200 mm	415918	-
		za dosjed rešetke dimenzije 250x250 mm	413546	-

ACO slivnik 157 FHD iz nehrđajućeg čelika – pribor

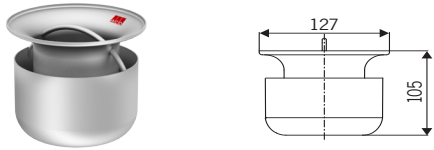
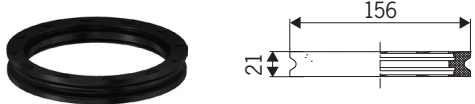
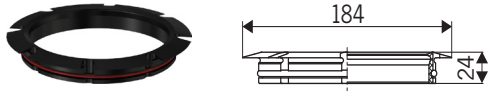
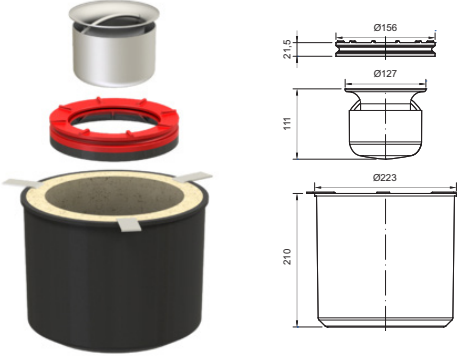
ACO slivnik 157 FHD – rezervni dijelovi

Ilustracija/Cртеж	FHD	Opis	Materijal brtve	Težina [kg]	Kvaliteta materijala	
					AISI 304	AISI 316L
	•	Zapor za miris	-	0,80	408200	408210
	•	Nosač zapora za miris	NBR	0,10	408201	
	•	Brtveni prsten - sa ili bez procjednih otvora	NBR	0,10	408205	
			ACO protupožarni kit za slivnik 157/DN 75		416932	
		<ul style="list-style-type: none"> • Jednodijelni slivnik, vertikalni • Teleskopski slivnik, vertikalni 				
			ACO protupožarni kit za slivnik 157/DN 100		416933	
		<ul style="list-style-type: none"> • Jednodijelni slivnik, vertikalni • Teleskopski slivnik, vertikalni 				